

**GUÍAS PARA CADENAS DE RODILLOS**

Roller chain guides

Guides pour chaînes à rouleaux

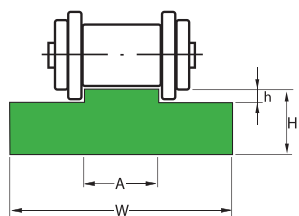

Ref.	ISO	Paso Pitch Pas	W	H	A	h	Kg/m
YS-1	06B1	3/8"	15	10	5,4	1,5	0,135
YS-2	08B1	1/2"	20	10	7,4	2,2	0,185
YS-3	10B1	5/8"	20	10	9,2	2,6	0,160
YS-315	10B1	5/8"	20	15	9,2	2,6	0,260
YS-4	12B1	3/4"	25	10	11,3	2,4	0,210
YS-415	12B1	3/4"	25	15	11,3	2,4	0,325
YS-5	16B1	1"	40	15	16,5	3,5	0,470
YS-520	16B1	1"	40	20	16,5	3,5	0,660
YS-6	20B1	1 1/4"	45	15	19	4,3	0,530
YS-620	20B1	1 1/4"	45	20	19	4,3	0,720
YS-7	24B1	1 1/2"	60	15	24,6	5,6	0,786
YS-8	28B1	1 3/4"	75	20	30	6,9	1,130
YS-9	32B1	2"	86	20	30	7,8	1,210

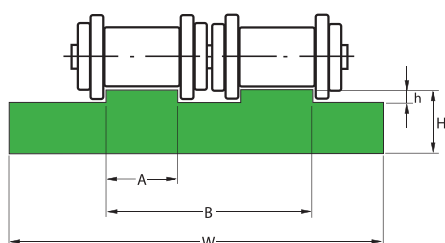

Ref.	ISO	Paso Pitch Pas	W	H	A	h	B	Kg/m
YD-1	06B2	3/8"	25	10	5,4	1,5	16	0,230
YD-2	08B2	1/2"	35	10	7,4	2,2	21	0,306
YD-3	10B2	5/8"	40	10	9,2	2,6	26	0,344
YD-315	10B2	5/8"	40	15	9,2	2,6	26	0,524
YD-4	12B2	3/4"	45	10	11,3	2,4	31	0,396
YD-415	12B2	3/4"	45	15	11,3	2,4	31	0,598
YD-5	16B2	1"	65	15	16,5	3,5	48	0,863
YD-520	16B2	1"	65	20	16,5	3,5	48	1,156
YD-6	20B2	1 1/4"	70	15	19	4,3	54,5	0,912
YD-620	20B2	1 1/4"	70	20	19	4,3	54,5	1,232
YD-7	24B2	1 1/2"	88	20	24,6	5,6	72	1,499
YD-8	28B2	1 3/4"	105	20	30	6,9	89	1,790
YD-9	32B2	2"	105	20	30	7,8	89	1,750

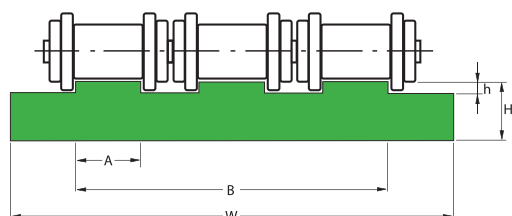

Ref.	ISO	Paso Pitch Pas	W	H	A	h	B	Kg/m
YT-1	06B3	3/8"	35	10	5,4	1,5	25,9	0,306
YT-2	08B3	1/2"	45	10	7,4	2,2	35,3	0,381
YT-215	08B3	1/2"	45	15	7,4	2,2	35,3	0,595
YT-220	08B3	1/2"	45	20	7,4	2,2	35,3	0,808
YT-3	10B3	5/8"	55	10	9,2	2,6	42,5	0,455
YT-4	12B3	3/4"	65	10	11,3	2,4	50,3	0,546
YT-5	16B3	1"	95	15	16,5	3,5	80,3	1,167
YT-6	20B3	1 1/4"	92	15	19,0	4,3	92,0	1,304
YT-7	24B3	1 1/2"	121	20	24,6	5,6	121,5	2,247
YT-8	28B3	1 3/4"	149	25	30,0	6,9	149,3	3,522
YT-9	32B3	2"	149	30	30,0	7,8	149,3	4,262

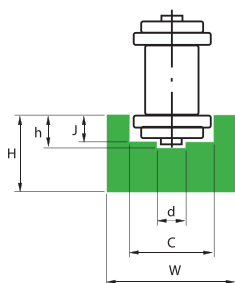

Ref.	ISO	Paso Pitch Pas	W	H	C	h	j	d	Kg/m
YU-1	06B	3/8"	20	15	9,2	4,2	2,8	4	0,257
YU-2	08B	1/2"	25	15	12,7	4,8	3,5	5	0,308
YU-3	10B	5/8"	25	15	15,2	5,1	3,6	6	0,296
YU-4	12B	3/4"	25	20	16,7	5,7	3,9	7	0,403
YU-5	16B	1"	35	25	24,4	10	8,4	9	0,624

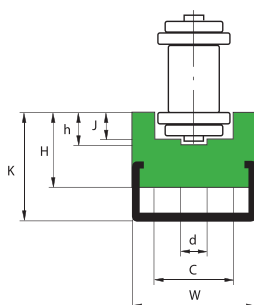

Ref.	ISO	Paso Pitch Pas	W	H	K	h	j	d	Perfil Profile Profil	Kg/m
YUCG-1	06B	3/8"	20	10	15	4,2	2,8	4	C2010	0,720
YUCG-2	08B	1/2"	25	15	22	4,8	3,5	5	C2812	1,140
YUCG-3	10B	5/8"	25	15	22	5,1	3,6	6	C2812	1,130
YUCG-4	12B	3/4"	25	20	27	5,7	3,9	7	C2812	1,270
YUCG-5	16B	1"	35	25	33	10	8,4	9	C3818	2,030

**GUÍAS PARA CADENAS DE RODILLOS**

Roller chain guides

Guides pour chaînes à rouleaux

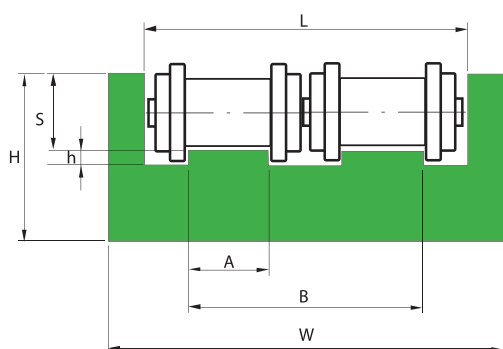
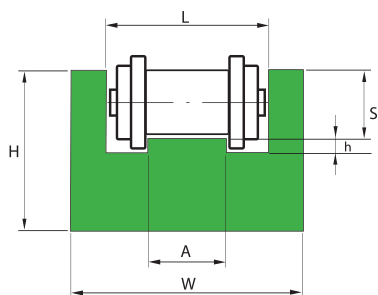
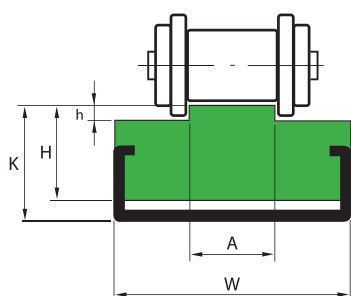
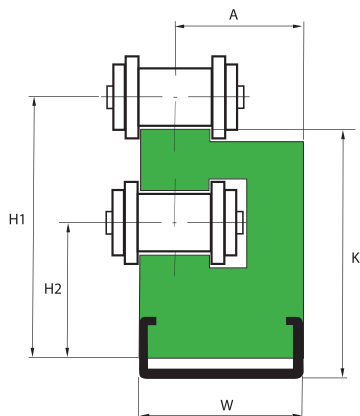

Ref.	ISO	Paso Pitch Pas	W	H1	H2	A	K	Perfil Profile Profil	Kg/m
Y2PCG-1	06B1	3/8"	20	30	15,5	17,3	27	C2010	0,900
Y2PCG-2	08B1	1/2"	20	34	18	16,5	30	C2010	0,960
Y2PCG-3	10B1	5/8"	20	41	19,5	15,5	36	C2010	1,120
Y2PCG-4	12B1	3/4"	28	46,5	23	22,3	41	C2812	1,700
Y2PCG-5	16B1	1"	38	62	31	29,5	54	C3818	3,100

Ref.	ISO	Paso Pitch Pas	W	H	K	h	A	Perfil Profile Profil	Kg/m
YTCG-1	06B1	3/8"	20	15	17	1,5	5,4	C2010	0,620
YTCG-2	08B1	1/2"	20	15	17	2,2	7,4	C2010	0,695
YTCG-3	10B1	5/8"	20	15	17	2,6	9,2	C2010	0,700
YTCG-4	12B1	3/4"	20	15	18	2,4	11,3	C2010	1,170
YTCG-5	16B1	1"	28	15	18	3,5	16,5	C2812	2,246
YTCG-6	20B1	1 1/4"	38	25	30	4,3	19,0	C3818	2,306
YTCG-7	24B1	1 1/2"	38	25	30	5,6	24,6	C3818	2,390
YTCG-8	28B1	1 3/4"	38	25	30	6,9	30	C3818	2,410
YTCG-9	32B1	2"	38	25	30	7,8	30	C3818	2,480

Ref.	ISO	Paso Pitch Pas	W	H	L	h	A	S	Kg/m
YUC-1	06B1	3/8"	25	10	15	1,5	5,4	4,4	0,170
YUC-2	08B1	1/2"	30	15	20	2,2	7,4	7,2	0,275
YUC-3	10B1	5/8"	33	20	23	2,6	9,2	9,5	0,405
YUC-4	12B1	3/4"	38	20	28	2,4	11,3	11,1	0,410
YUC-5	16B1	1"	51	25	41	3,5	16,5	16,5	0,510

Ref.	ISO	Paso Pitch Pas	W	H	L	h	A	S	Kg/m
YUCD -1	06B2	3/8"	36	15	26	1,5	5,4	4,4	0,390
YUCD -2	08B2	1/2"	45	20	35	2,2	7,4	7,2	0,620
YUCD -3	10B2	5/8"	50	25	40	2,6	9,2	9,5	0,816
YUCD -4	12B2	3/4"	56	25	46	2,4	11,3	11,1	0,810
YUCD -5	16B2	1"	85	30	75	3,5	16,5	16,5	1,200

Disponibile en perfil de acero inoxidable y acero galvanizado  
Stainless steel and galvanized steel profile available  
Profil disponible en acier inox et galvanisé

Largos estándar de 2 metros  
Standard length 2 meters  
Longueur standard 2 m

# GUÍAS PARA CADENAS DE RODILLOS

Roller chain guides

Guides pour chaînes à rouleaux

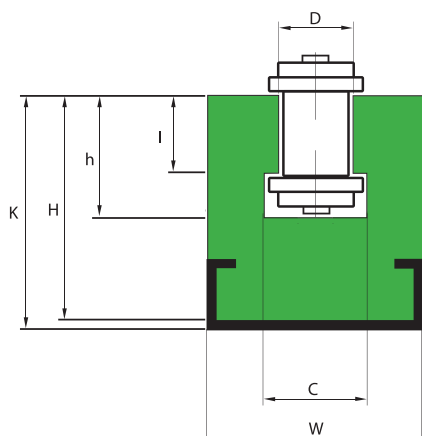
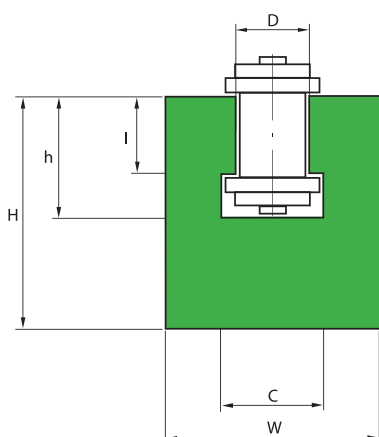
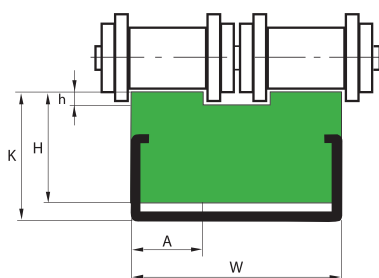
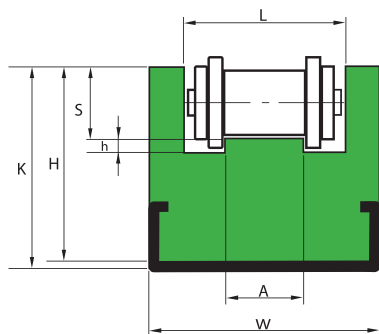

Ref.	ISO	Paso Pitch Pas	W	H	K	L	h	A	S	Perfil Profile Profil	Kg/m
YUCCG-1	06B1	3/8"	25	15	18	15	1,5	5,4	4,4	C2010	0,760
YUCCG-2	08B1	1/2"	30	25	27	20	2,2	7,4	7,2	C2812	1,100
YUCCG-3	10B1	5/8"	33	30	32	23	2,6	9,2	9,5	C2812	1,305
YUCCG-4	12B1	3/4"	38	35	38	28	2,4	11,3	11,1	C3818	2,335
YUCCG-5	16B1	1"	51	40	45	41	3,5	16,5	16,5	C3818	2,440

Ref.	ISO	Paso Pitch Pas	W	H	K	h	A	Perfil Profile Profil	Kg/m
YTCDG-1	06B2	3/8"	15,5	10	15	1,5	5,4	C2010	0,615
YTCDG-2	08B2	1/2"	21,5	10	17	2,2	7,4	C2010	0,715
YTCDG-3	10B2	5/8"	26	15	17	2,6	9,2	C2812	1,165
YTCDG-4	12B2	3/4"	30,7	15	18	2,4	11,3	C2812	1,200

Ref.	ISO	Paso Pitch Pas	W	H	C	h	I	D	Kg/m
YGH-1	06B	3/8"	20	25	9,3	10	5,6	6,6	0,414
YGH-2	08B	1/2"	24	30	12,8	12,7	7,6	8,7	0,564
YGH-3	10B	5/8"	30	35	15,4	14,8	9,5	10,4	0,832
YGH-4	12B	3/4"	40	35	16,9	17,5	11,5	12,3	1,106
YGH-5	16B	1"	40	45	24,4	26,8	16,9	16,1	1,231
YGH-6	20B	1 1/4"	50	50	27,5	31,2	19,4	19,3	1,726
YGH-7	24B	1 1/2"	60	60	36,5	40,1	25,2	25,7	2,332
YGH-8	28B	1 3/4"	70	70	41,5	48,9	30,8	28,3	3,173
YGH-9	32B	2"	75	75	44,5	53,0	30,8	29,6	3,264

Ref.	ISO	Paso Pitch Pas	W	H	K	I	h	D	C	Perfil Profile Profil	Kg/m
YGHLCG-1	06B	3/8"	20	17,5	21	5,6	9,9	6,6	9,3	C2010	0,622
YGHLCG-2	08B	1/2"	28	27,5	32	7,6	12,7	8,7	12,8	C2812	1,450
YGHLCG-3	10B	5/8"	28	27,5	32	9,3	14,8	10,4	15,4	C2812	1,402
YGHLCG-4	12B	3/4"	38	34,0	43	11,5	17,5	12,3	16,9	C3818	1,709
YGHLCG-5	16B	1"	38	40	50	16,9	26,8	16,1	24,4	C3818	1,600
YGHLCG-6	20B	1 1/4"	60	45	55	19,4	31,2	19,3	27,5	C6020	4,800
YGHLCG-7	24B	1 1/2"	60	55	65	25,2	40,1	25,7	36,5	C6020	5,000
YGHLCG-8	28B	1 3/4"	70	70	80	30,8	48,9	28,3	41,5	C6020	6,200
YGHLCG-9	32B	2"	70	70	80	30,8	53,0	29,6	44,5	C6020	6,200

## GUÍAS PARA CADENAS DE RODILLOS

Roller chain guides

Guides pour chaînes à rouleaux

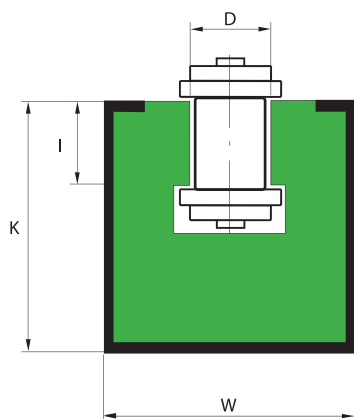

Ref.	ISO	Paso Pitch Pas	W	K	I	D	Perfil Profile Profil	Kg/m
YGHCG-1	06B	3/8"	30	24	5,6	6,6	C3024	2,150
YGHCG-2	08B	1/2"	30	24	7,6	8,7	C3024	2,150
YGHCG-3	10B	5/8"	30	24	9,3	10,4	C3024	2,100
YGHCG-4	12B	3/4"	30	24	11,5	12,3	C3024	2,060
YGHCG-5	16B	1"	45	40	16,9	16,1	C4540	2,060

## GUÍA YGHCG PARA PERFIL METÁLICO C-15

Guide YGHCG for metal profile C-15

Guide YGHCG pour profil métallique C-15

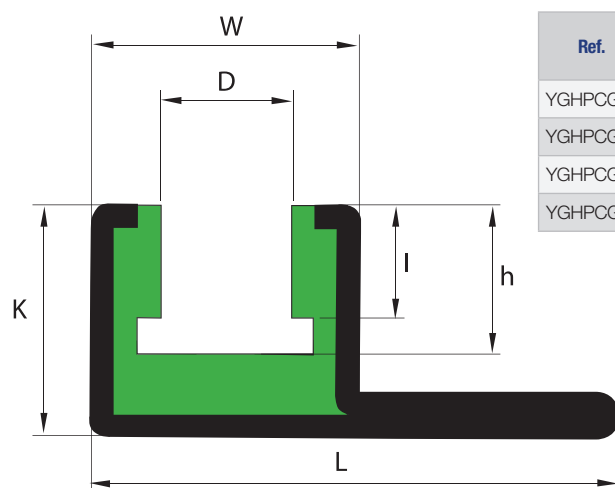

Ref.	ISO	Paso Pitch Pas	K	W	L	I	h	D	Kg/m
YGHPCG-1	06B	3/8"	25	31	53	5,6	9,9	6,6	2,340
YGHPCG-2	08B	1/2"	25	31	53	7,6	12,7	8,7	2,300
YGHPCG-3	10B	5/8"	25	31	53	9,3	14,8	10,4	2,250
YGHPCG-4	12B	3/4"	25	31	53	11,5	17,5	12,3	2,250

## GUÍA YGHCG PARA PERFIL METÁLICO C-14

Guide YGHCG for metal profile C-14

Guide YGHCG pour profil métallique C-14

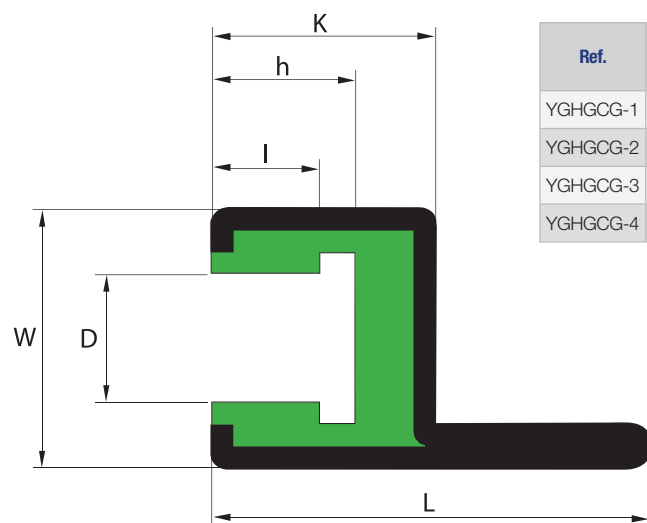

Ref.	ISO	Paso Pitch Pas	K	W	L	I	h	D	Kg/m
YGHGCG-1	06B	3/8"	25	31	47	5,6	9,9	6,6	2,150
YGHGCG-2	08B	1/2"	25	31	47	7,6	12,7	8,7	2,150
YGHGCG-3	10B	5/8"	25	31	47	9,3	14,8	10,4	2,100
YGHGCG-4	12B	3/4"	25	31	47	11,5	17,5	12,3	2,060

Disponible en perfil de acero inoxidable y acero galvanizado  
Stainless steel and galvanized steel profile available  
Profil disponible en acier inox et galvanisé

Largo estándar de 2 metros  
Standart length 2 metres  
Longueur standart 2 m